



POLYMER CONCRETE BOX & COVER



MODEL 4848/36 PC

COVER

Dimensions*	45 3/8" x 45 3/8" x 3"
Material	Polymer Concrete
Style	Flush Split
Fasteners	3/8-16 x 3" SS Hex Bolt
Lift points	1/4" SS Rod

Custom logo available

Body

Dimensions*	48 3/4" x 48 3/4" x 36"
Material	Polymer Concrete

Additional body depths available

Notes

Rating Tier 22

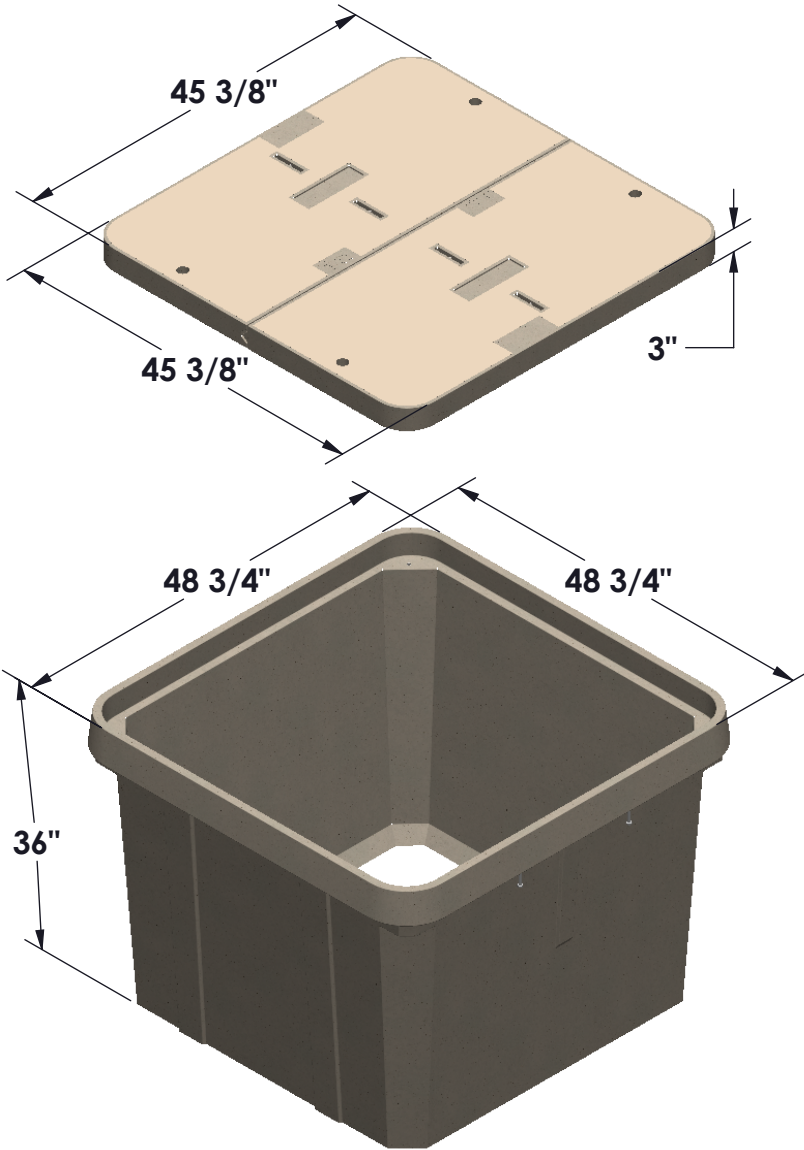

* All dimensions & weights are approximate.

Lateral Loading Requirements

Design Load: 800lbs/sq. ft
Test Load: 1200lbs/sq. ft

Vertical Loading Requirements

Design Load: 22,500lbs
Test Load: 33,750lbs