

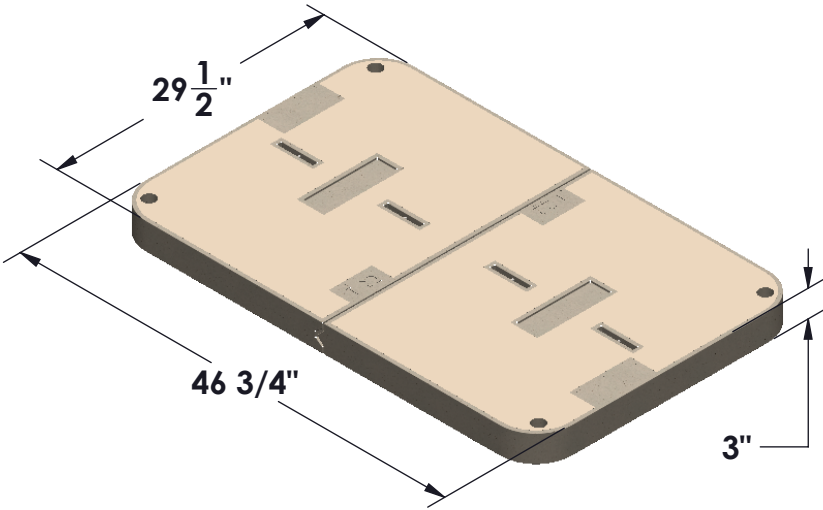

POLYMER CONCRETE BOX & COVER



MODEL 3048/24 PC



COVER

Dimensions*	46 3/4" x 29 1/2" x 3"
Material	Polymer Concrete
Style	Flush Split
Fasteners	3/8-16 x 3" SS Hex Bolt
Lift points	1/4" SS Rod

Custom logo available

Body

Dimensions*	49 1/4" x 31 3/4" x 24"
Material	Polymer Concrete

Additional body depths available

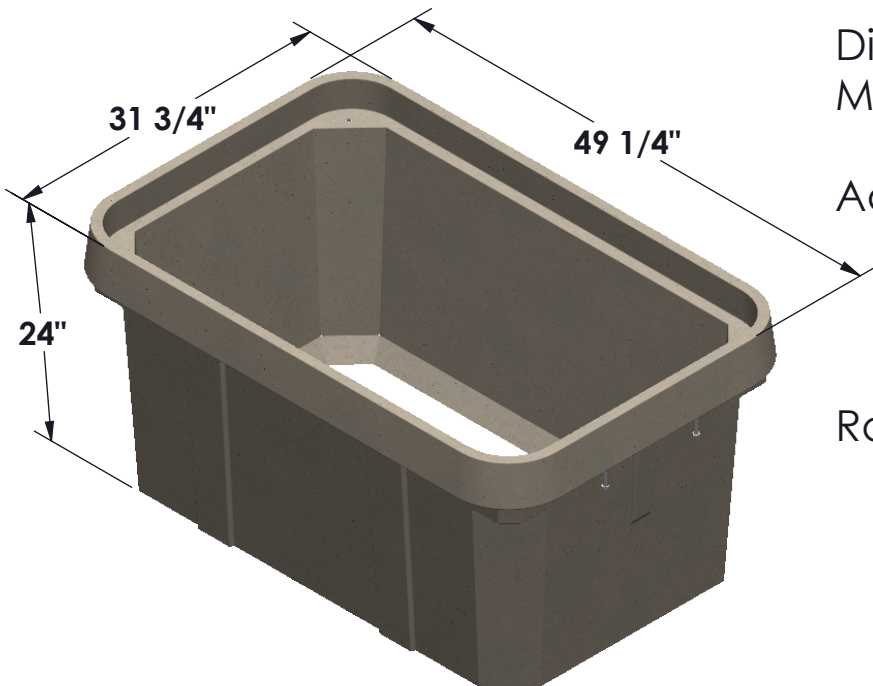

Notes

Rating Tier 22

* All dimensions & weights are approximate.

Lateral Loading Requirements

Design Load: 800lbs/sq. ft
Test Load: 1200lbs/sq. ft

Vertical Loading Requirements

Design Load: 22,500lbs
Test Load: 33,750lbs