



POLYMER CONCRETE BOX & COVER



MODEL 2436/36 PC

COVER

Dimensions*	35 1/8" x 23 5/8" x 3"
Material	Polymer Concrete
Style	Single Piece
Fasteners	3/8-16 x 3" SS Hex Bolt
Lift points	1/4" SS Rod

Custom logo available

Body

Dimensions*	37 3/8" x 26" x 36"
Material	Polymer Concrete

Additional body depths available

Notes

Rating Tier 22

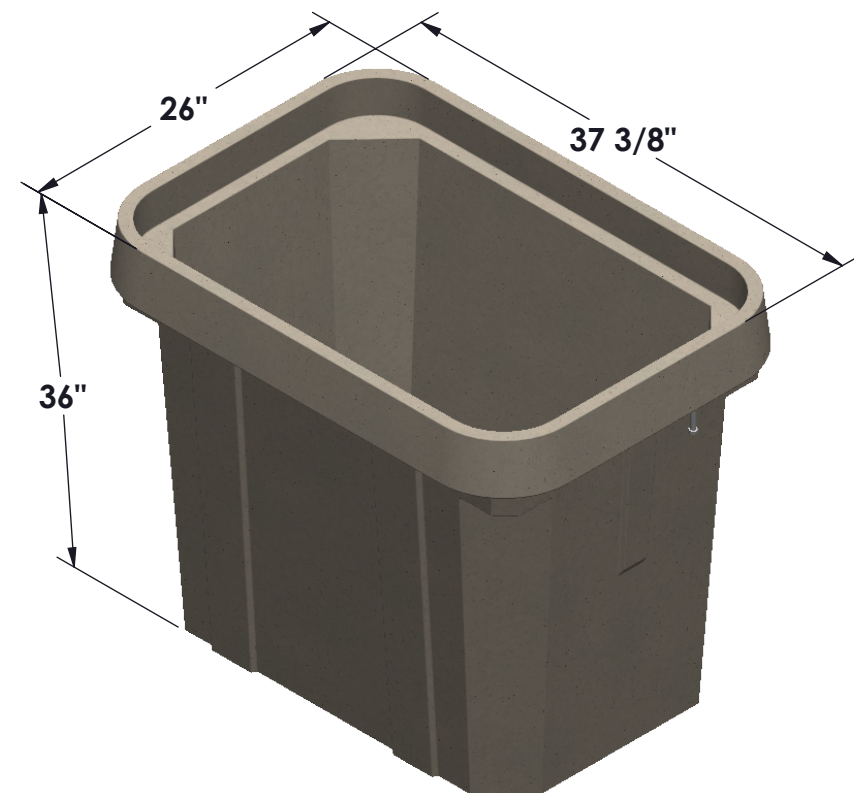
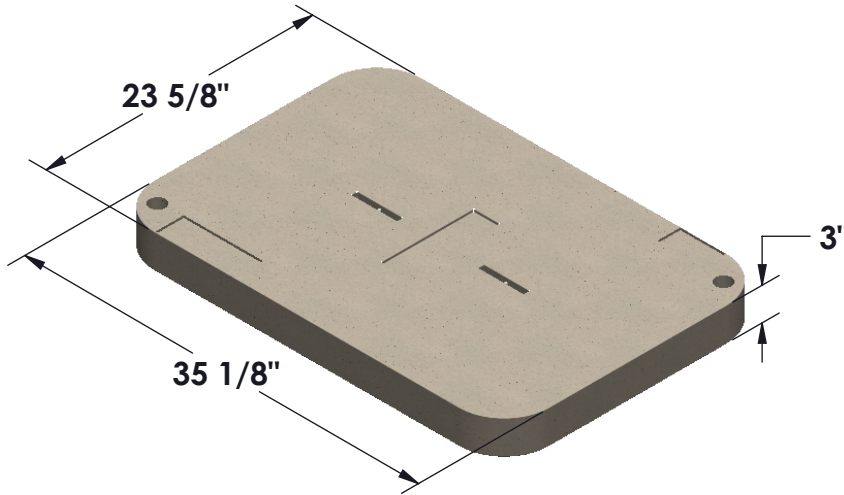

* All dimensions & weights are approximate.

Lateral Loading Requirements

Design Load: 800lbs/sq. ft
Test Load: 1200lbs/sq. ft

Vertical Loading Requirements

Design Load: 22,500lbs
Test Load: 33,750lbs